

(X09-363X-XX) (A/3)

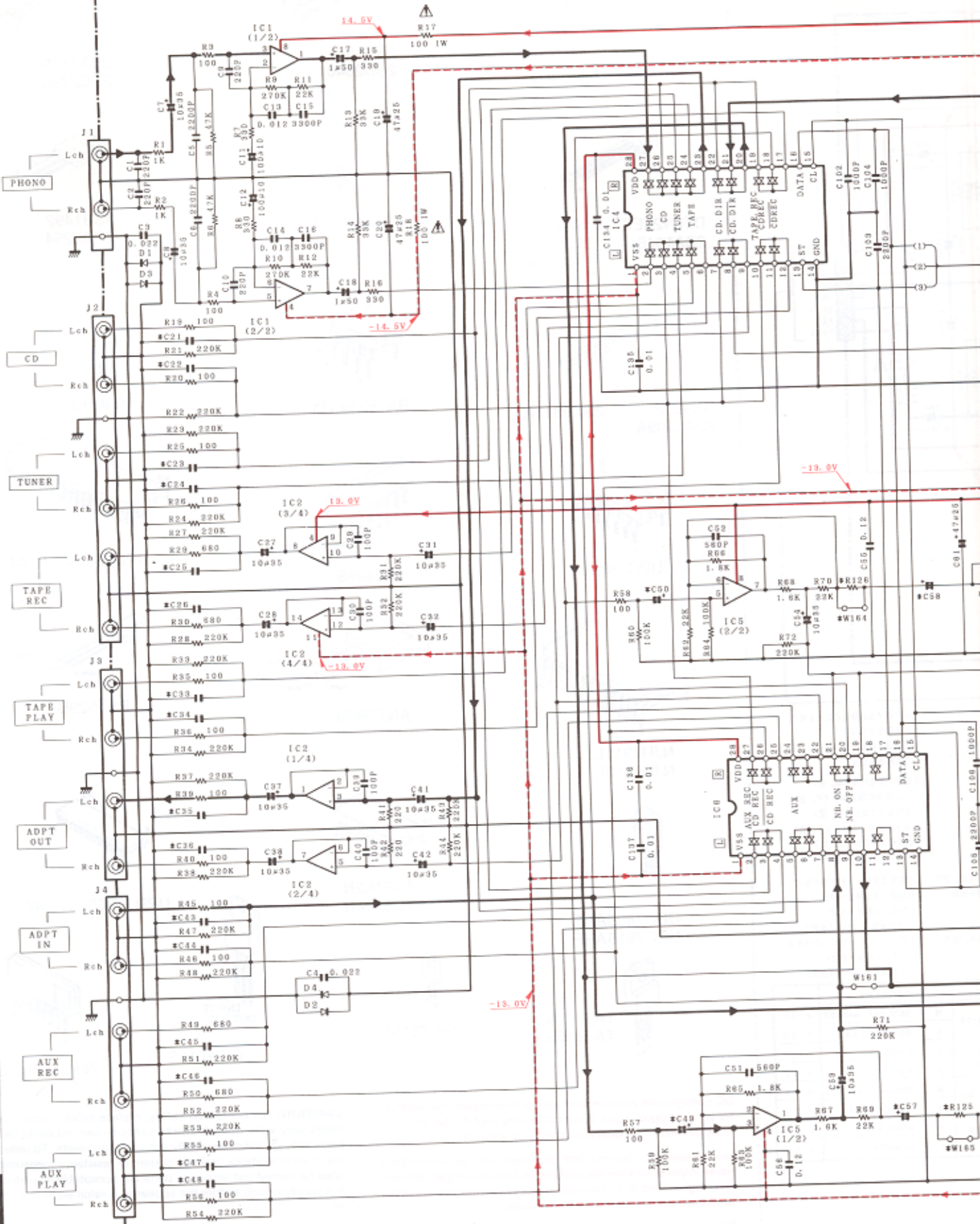

Kenwood
A-8177

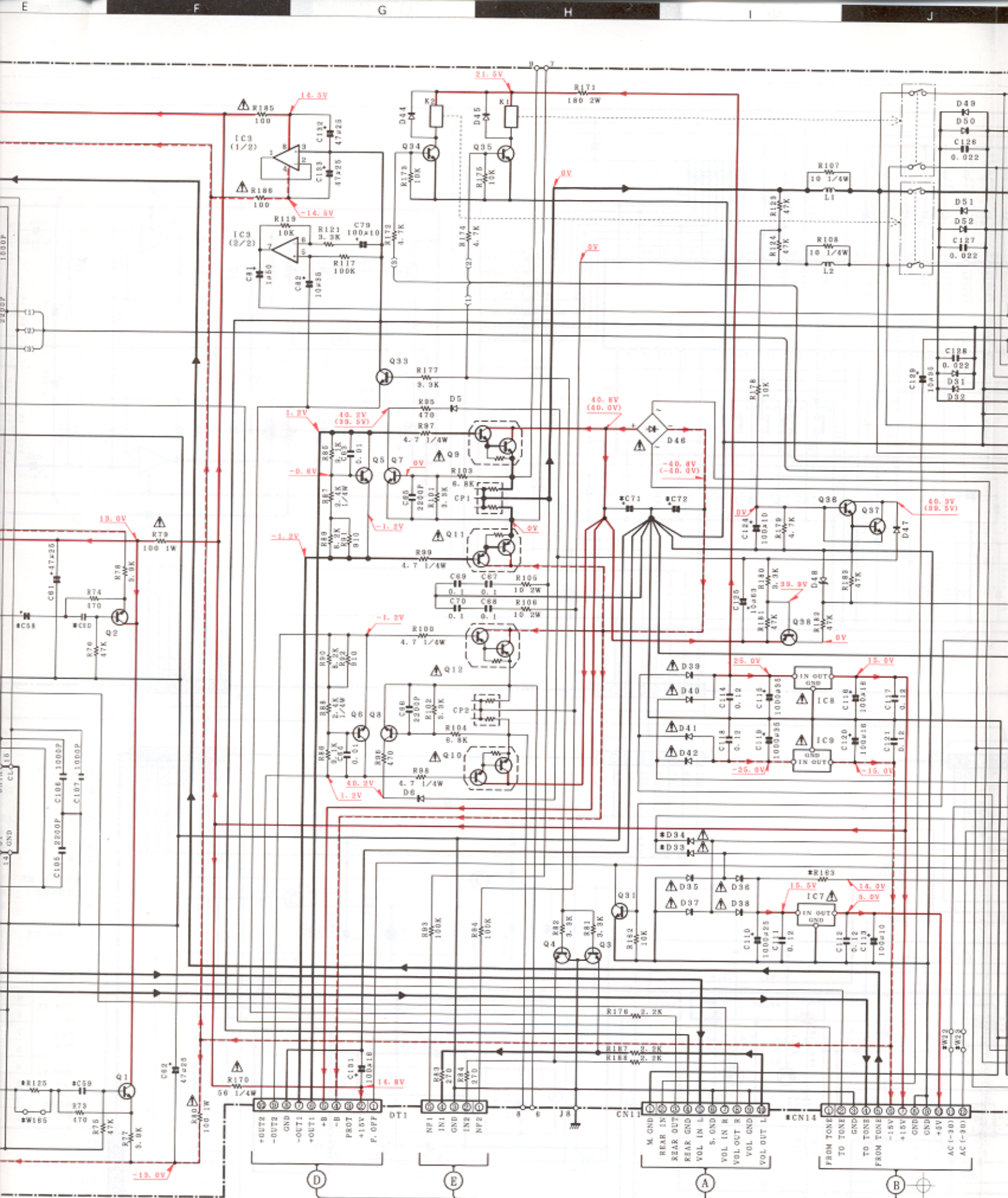



DT1 X85-12XX-XX

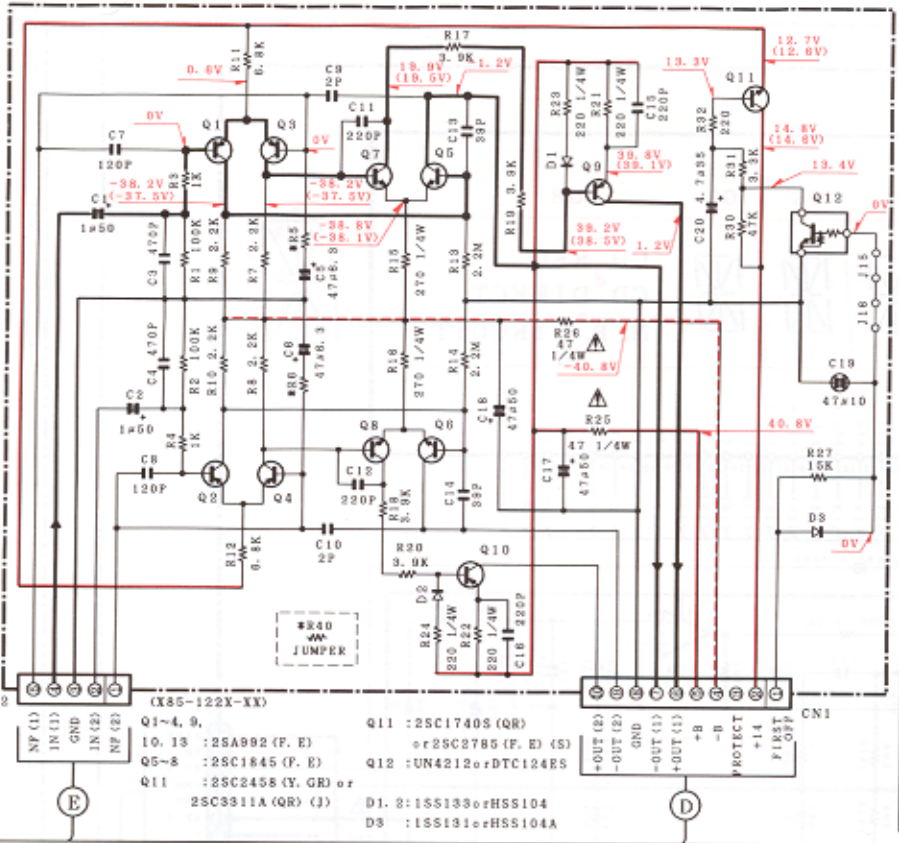
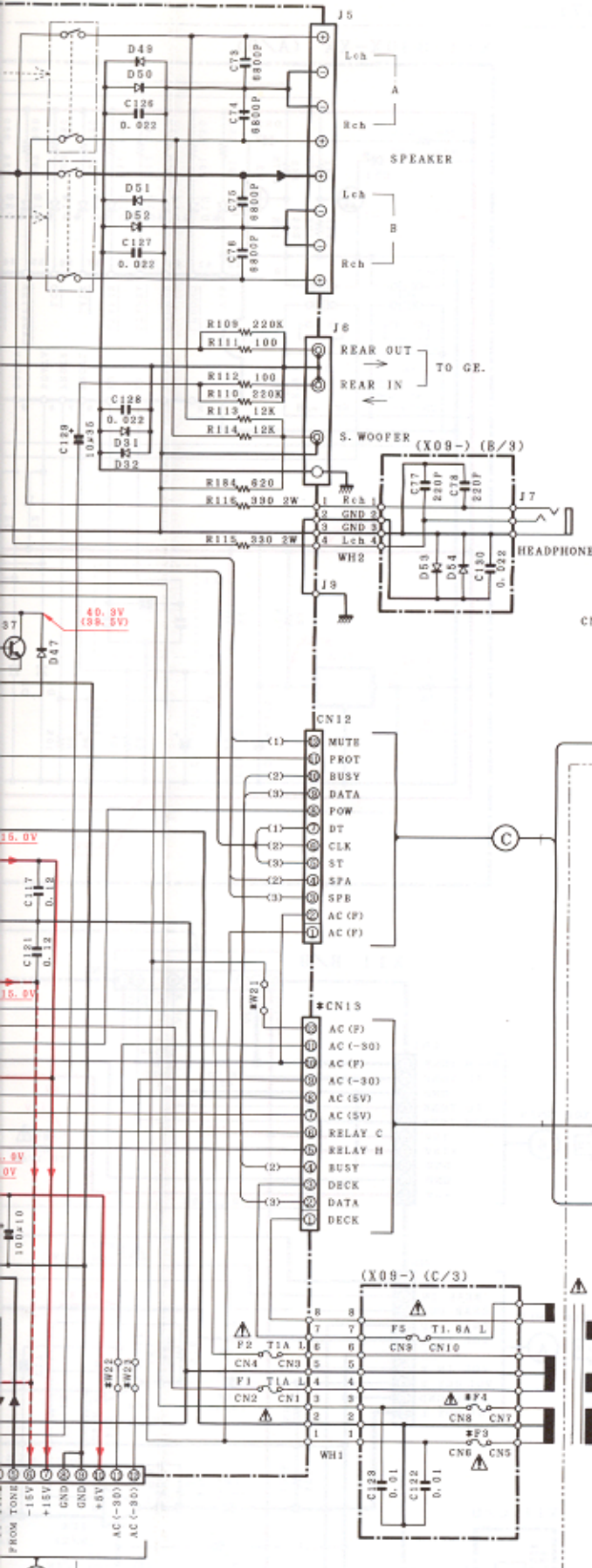

(M TYPE ONLY)

D24 : 1SS131 or HSS104

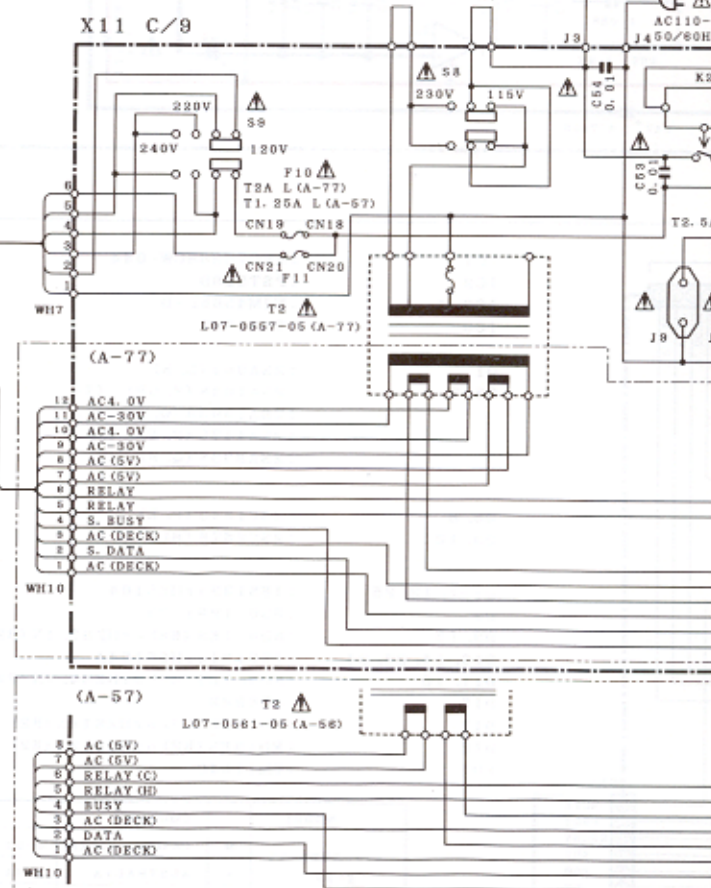

(X85)
 MO
 A-7
 JAP
 MAD
 A-7
 SINGA
 MAD
 A-5

DX or BA15218-DX	Q1, 2, 7, 8	: 2SC1845 (F, E)	D1~6, 31, 32	
or NJM2058D	Q3, 4, 33	: 2SC2878 (A, B)	44, 45,	
or TC9164N	Q5, 6	: 2SC4137 (V, W)	47, 48~54	: 1SS133 or HSS104
or TC9162N	Q9, 10	: 2SD2254 (A-77)	D35~42	: S5688B or
or TA7805S or		2SD2340 (A-57)		1SR199-100
or TA7805S or	Q11, 12	: 2SB1492 (A-77)	D46	: RBV-602LFA or
or PC7815AHF		2SB1531 (A-57)		D5SBA20F03
	Q31, 34~37	: 2SC2003 (L, K)	D48	: RD4.7ES (B2) or
	Q98	: 2SA938S (Q, R) or		HZS4.7N (B2)
		2SA1175 (F, E)		

ENTRY	CN13	CN14	D33, 34	C21~26, 33~36, 43~44	C49, 50	C57, 58	C59, 60	C71, 72	R125	R128	R163	F3, 4	W21~23	
L MARKET LIA	0-23	12P	12P	NO	0.047μ	4.7μ35	0.1μ	6800μ63	W165	W164				
D	2-72	12P	12P		220P	10μ35	1μ	0.33μ	6800μ63	4.7K	4.7K			
L MARKET LIA	0-21	12P	12P	NO	0.047μ	4.7μ35	0.1μ	6800μ63	W165	W164	47 2W	T4A L	YES	
D	2-70	12P	12P		220P	10μ35	1μ	0.33μ	6800μ63	4.7K	4.7K			
L MARKET LIA	0-22	8P	10P	NO	0.1μ	4.7μ35	0.1μ	5600μ	2.2K	2.2K				
D	2-71	8P	10P		220P	10μ35	1μ	0.33μ	5600μ	2.0K	2.0K			
L MARKET LIA	0-24	8P	10P	YES	NO	0.1μ	4.7μ35	0.1μ	5600μ	2.2K	2.2K	82 2W	T2.5A L	NO
D	2-73	8P	10P		220P	10μ35	1μ	0.33μ	5600μ	2.0K	2.0K			

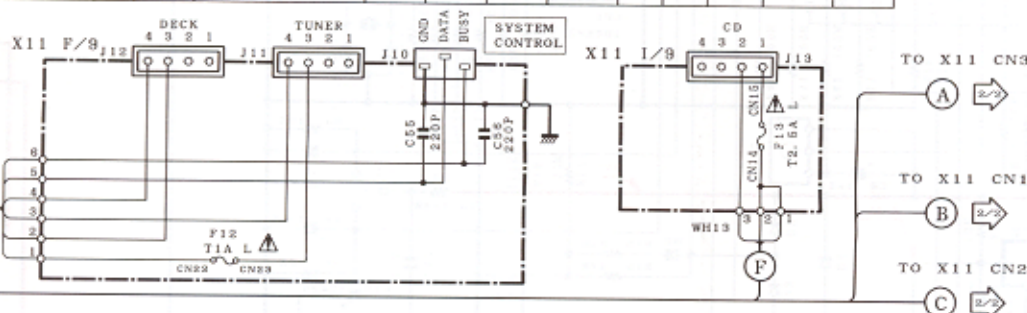

(E, T, X TYPE ONLY)

X11 D/9

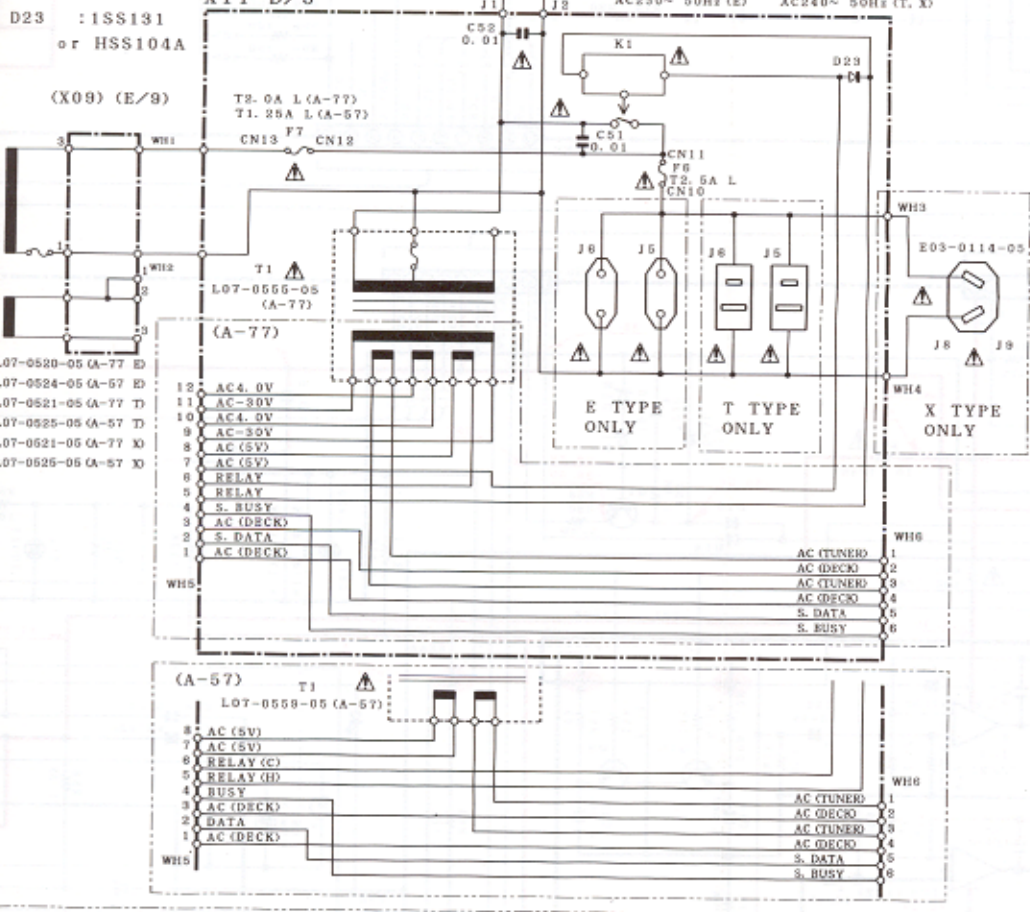

— SIGNAL LINE
 — GND LINE
 — +B LINE
 - - - -B LINE

DC voltages are as measured with a high impedance voltmeter with no signal input. Values may vary slightly due to variations between individual instruments or/and units.

Les tensions c.c. doivent être mesurées avec un voltmètre haute impédance sans signal d'entrée. Les valeurs peuvent différer légèrement du fait des variations inhérentes aux appareils et aux instruments de mesure individuels.

Die angegebenen Gleichspannungswerte wurden mit einer hochohmigen Spannungsmesser ohne Eingangssignal gemessen. Dabei schwanken die Meßwerte aufgrund von Unterschieden zwischen einzelnen Instrumenten oder Geräten um U. geringfügig.

CAUTION: For continued safety, replace safety critical components only with manufacturer's recommended parts (refer parts list). ⚠ Indicates safety critical components. To reduce risk of electric shock, leakage-current or resistance measurement shall be carried out (exposed parts are acceptably insulated from the supply circuit) before the appliance is returned to the customer.

X11-33XX-XX (A/9)

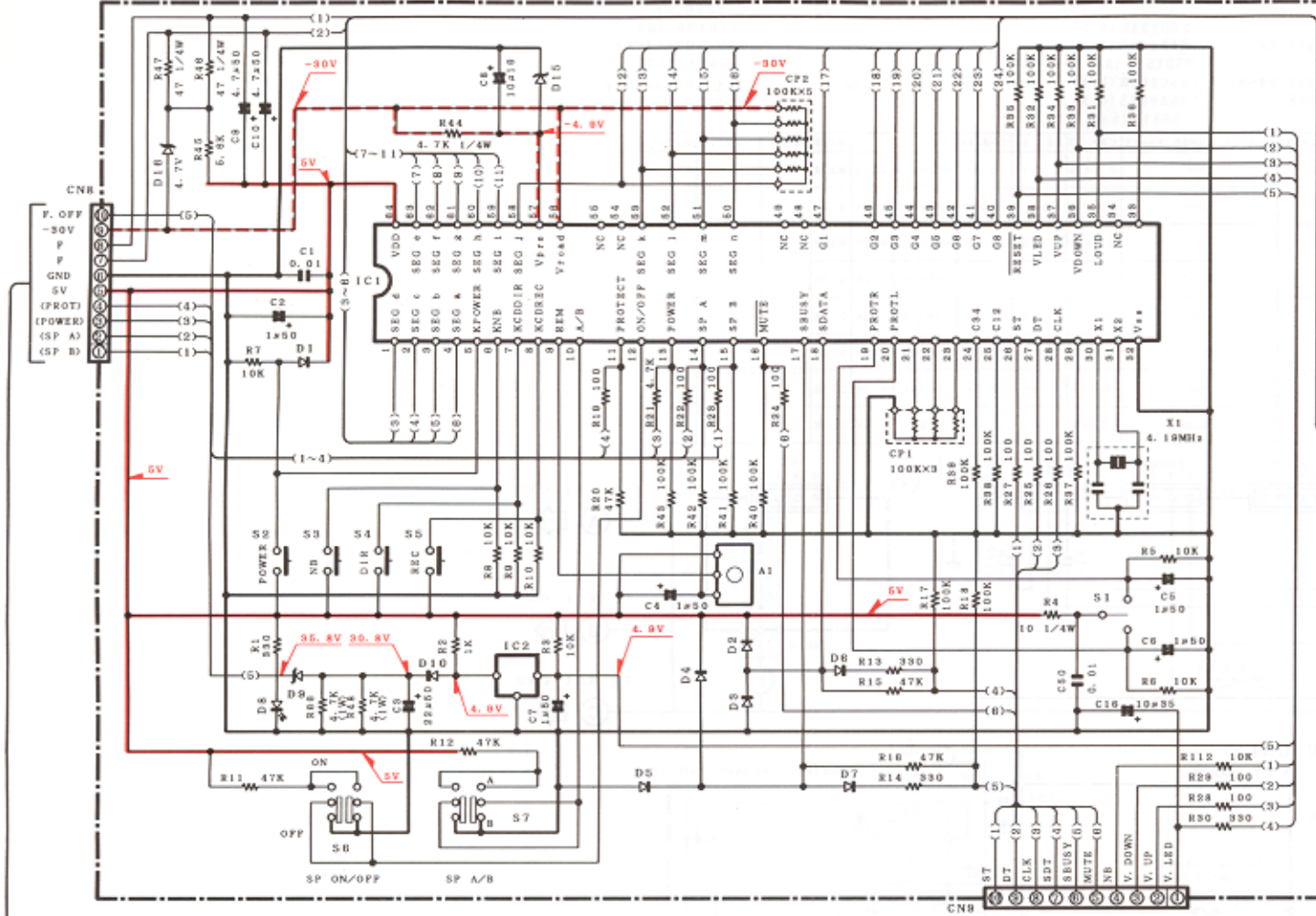

X11 B/9

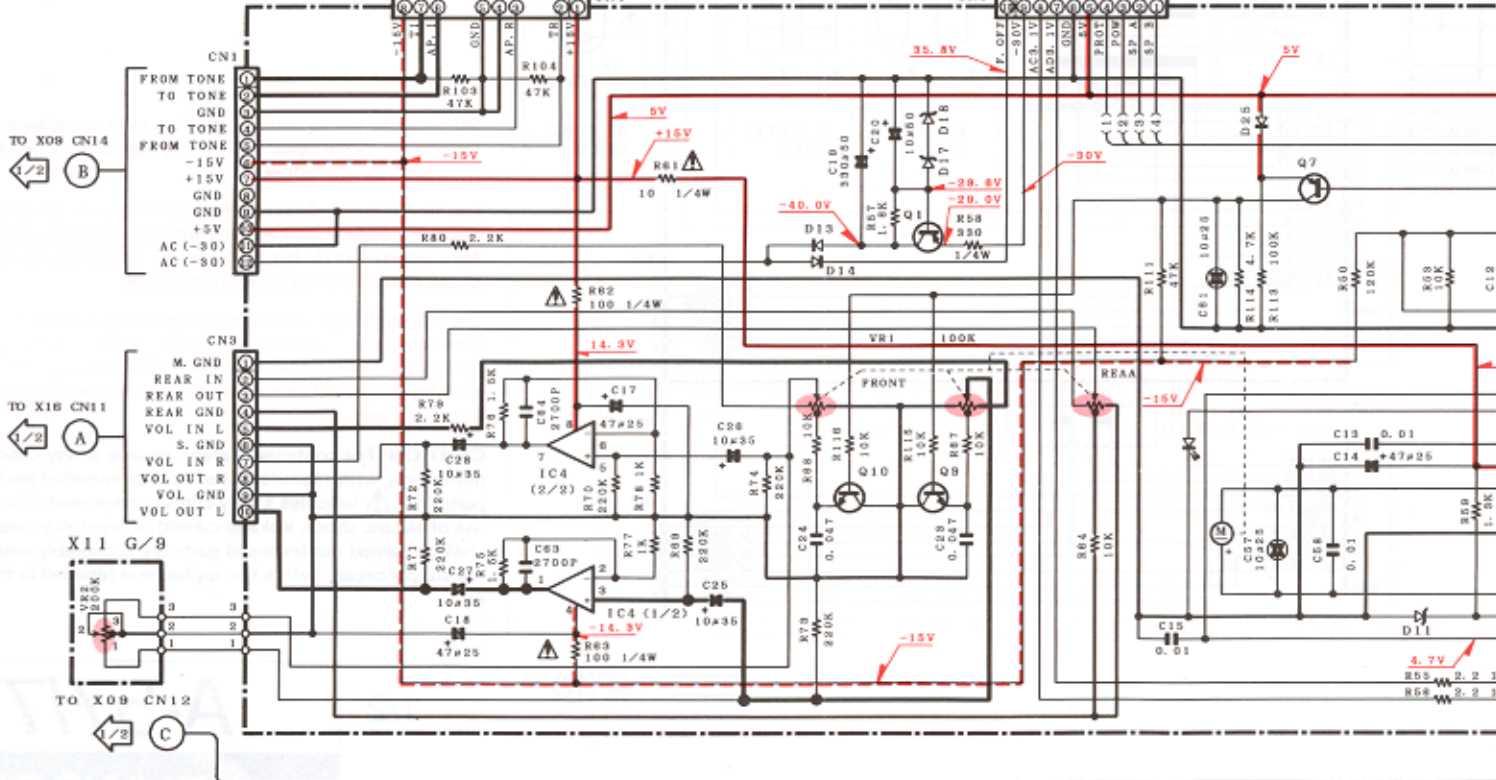

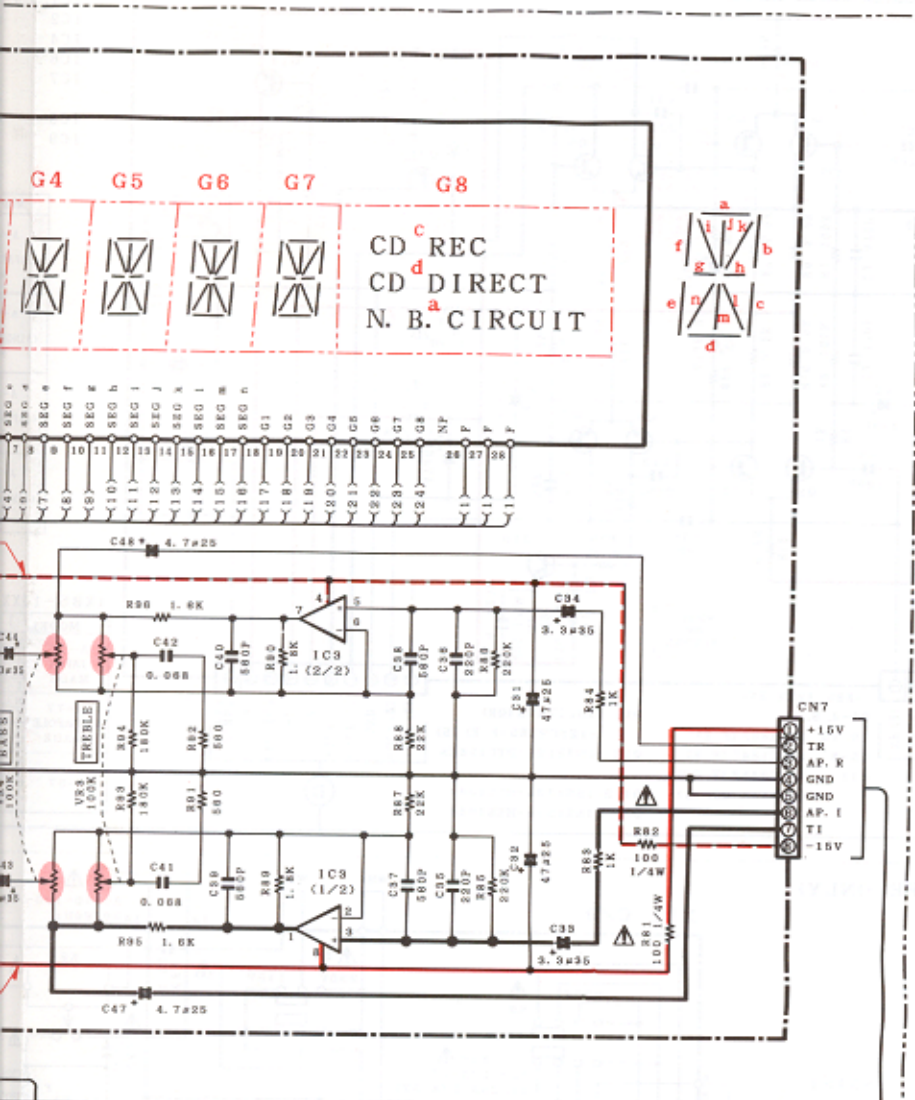

- IC1 : #PD75288CW-044
- IC2 : PST529D
- IC3, 4 : NJM4565L-D
- IC5 : TA8409S
- Q1 : 2SA954 (L, K)
- Q3, 7 : 2SA1048 (Y, GR) (J)
- : 2SA1309A (Q, R) (J)
- : 2SA1175 (F, E) (S)
- : 2SA933S (Q, R) (S)
- Q5, 6 : 2SC1845 (F, E)
- Q9, 10 : 2SC2878 (B)
- D1~7, 12, 25 : ISS133 or HSS104
- D8 : B30-1291-05
- D9, 15 : RD5.1ES (B2) or HZS5.1N (B2)
- D10, 14, 23, 24 : ISS131 or HSS104A
- D11, 16 : RD4.7ES (B2) or HZS4.7N (B2)
- D13 : S5688B
- D17 : RD16ES (B2) or HZS16N (B2)
- D18 : RD13ES (B2) or HZS13N (B2)
- ED1 : CM1154C

MODEL	COUNTRY	
X11-332X-XX A-77 (JAPAN MADE)	M	GENERAL MARKET 0-21
	X	AUSTRALIA 0-71
	T	ENGLAND 0-51
X11-334X-XX A-77 (SINGAPORE MADE)	E	EUROPE 2-70
	M	GENERAL MARKET 0-21
	X	AUSTRALIA 0-71
	T	ENGLAND 0-51
	E	EUROPE 2-70

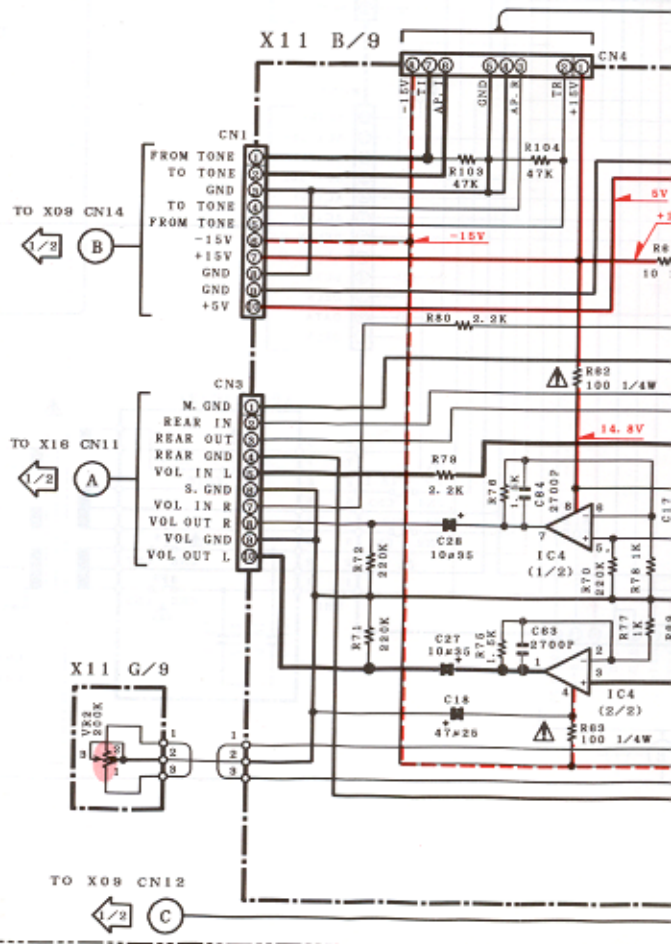
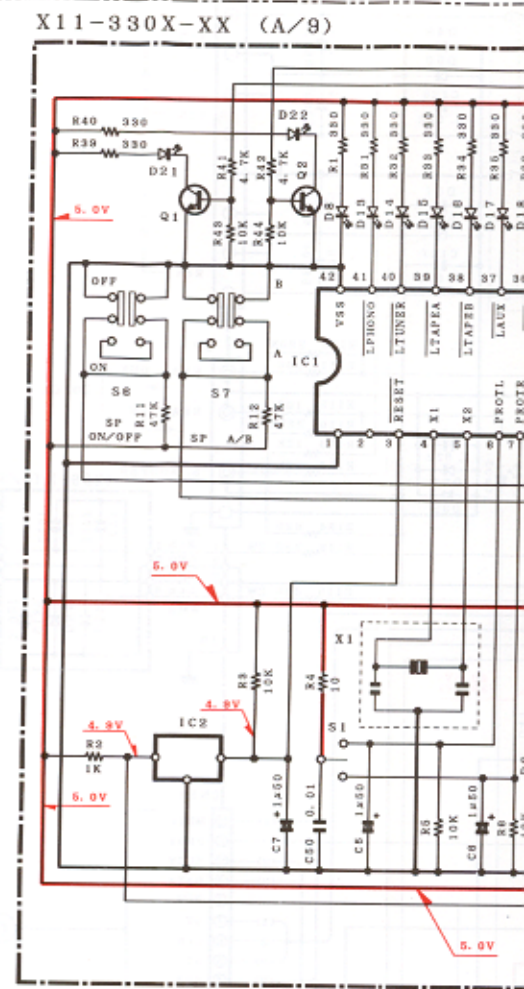
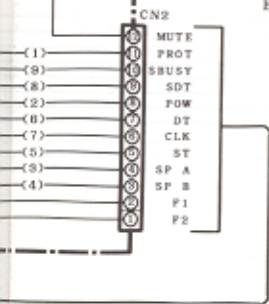

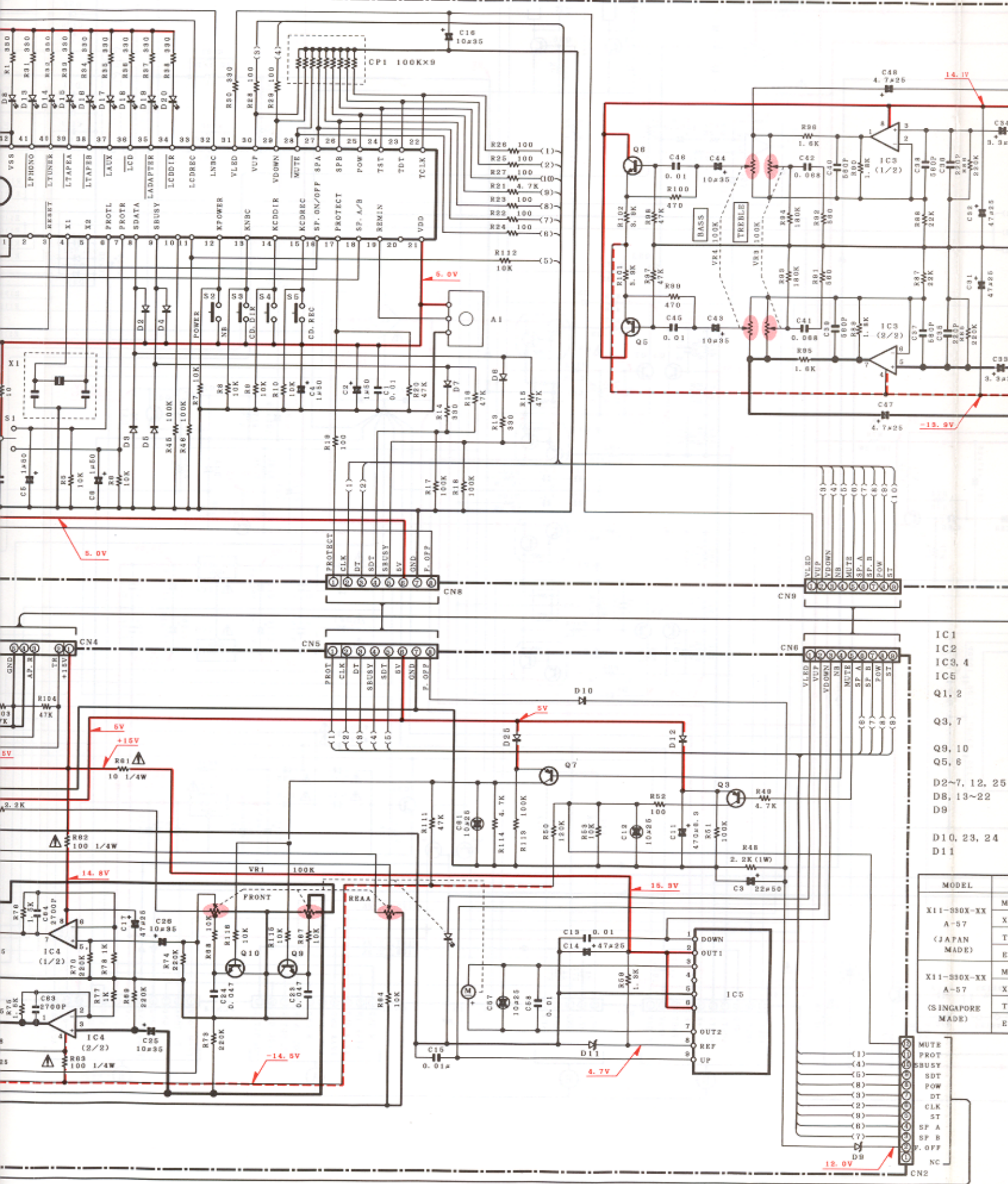

- IC1
- IC2
- IC3, 4
- IC5
- Q1, 2
- Q3, 7
- Q9, 10
- Q5, 6
- D2-7, 12, 25
- DB, 13-22
- D9
- D10, 23, 24
- D11

MODEL	
X11-330X-XX	M
A-57	X
(JAPAN MADE)	T
	E
X11-330X-XX	M
A-57	X
(SINGAPORE MADE)	T
	E



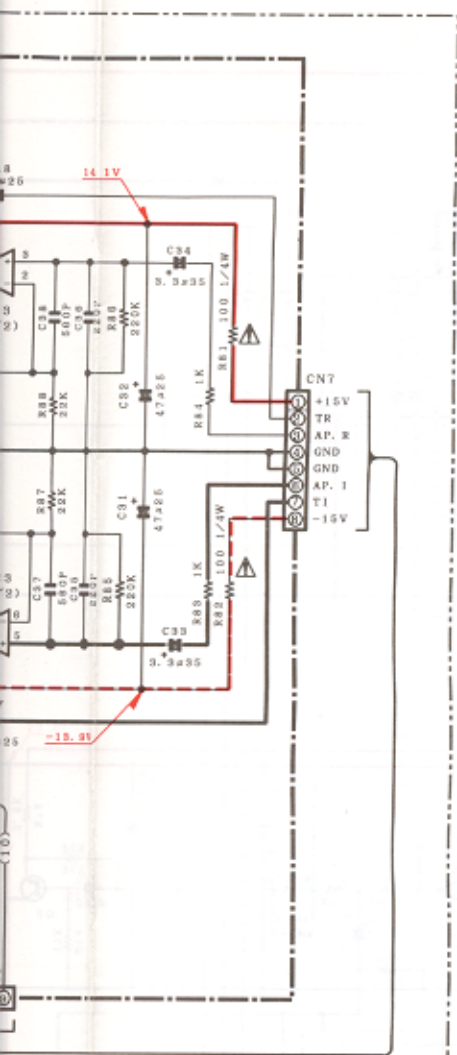

- IC1 : #PD75004CU-147
- IC2 : PST529D
- IC3, 4 : NJM4565L-D
- IC5 : TA8409S
- Q1, 2 : 2SC1740S (Q, R)
or 2SC2785 (F, E)
- Q3, 7 : 2SA933S (Q, R)
or 2SA1175 (F, E)
- Q9, 10 : 2SC2878 (A, B)
- Q5, 6 : 2SC1845 (F, E)
- D2~7, 12, 25 : ISS133 or HSS104
- D8, 13~22 : B30-1291-05
- D9 : RD5.1ES (B2)
or HZS5.1N (B2)
- D10, 23, 24 : ISS131 or HSS104A
- D11 : RD4.7ES (B2)
or HZS4.7N (B2)

MODEL	COUNTRY	
X11-330X-XX A-57 (JAPAN MADE)	M	GENERAL MARKET 0-22
	X	AUSTRALIA 0-72
	T	ENGLAND 0-52
	E	EUROPE 2-71
X11-330X-XX A-57 (SINGAPORE MADE)	M	GENERAL MARKET 0-21
	X	AUSTRALIA 0-71
	T	ENGLAND 0-51
	E	EUROPE 2-70

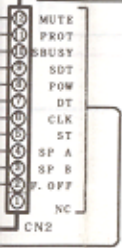

2SA954
2SA992

2SC1845
2SC2003
2SC2878

2SB1531
2SD2340

2SA1175
2SC2785

DTC124ES
2SA1048

2SA933S
2SC1740C
2SC2458

2SC4137

2SB1492
2SD2254

UN4212
2SA1309A

2SC3311A

BA15218-DX

NJM2058D

UPC4574C

TA8409S

UPD75004CU-147

AN77805F

PST529D

NJU7311L
NJU7313L

TC9162N
TC9164N

UPD75268CW-044

UPC7805AHF
UPC7815AHF

TA7805S
TA7815S

UPC7915F

TA79015S

NJM4565L-D

DC voltages are as measured with a high impedance voltmeter with no signal input. Values may vary slightly due to variations between individual instruments or/and units.

Les tensions c.c. doivent être mesurées avec un voltmètre à haute impédance sans signal d'entrée. Les valeurs peuvent différer légèrement du fait des variations inhérentes aux appareils et aux instruments de mesure individuels.

Die angegebenen Gleichspannungswerte wurden mit einem hochohmigen Spannungsmesser ohne Eingangssignal gemessen. Dabei schwanken die Meßwerte aufgrund von Unterschieden zwischen einzelnen Instrumenten oder Geräten u. U. geringfügig.



CAUTION: For continued safety, replace safety critical components only with manufacturer's recommended parts (refer to parts list). Indicates safety critical components. To reduce the risk of electric shock, leakage-current or resistance measurements shall be carried out (exposed parts are acceptably insulated from the supply circuit) before the appliance is returned to the customer.

A-57/77

KENWOOD

A-57/77

EXPLODED VIEW (UNIT)

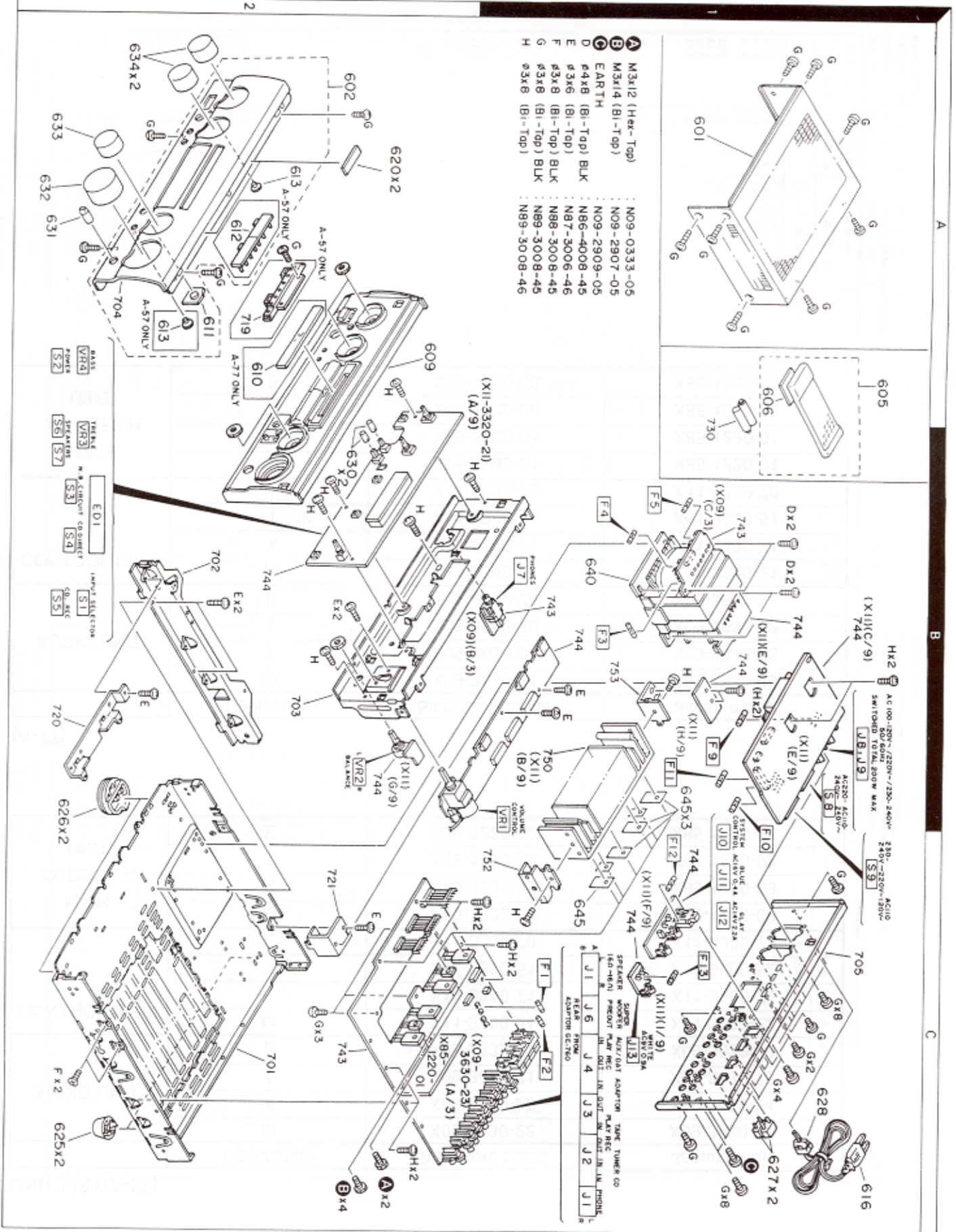

* New Parts
Parts without Parts No. are not supplied.
Les articles non mentionnés dans le Parts No. ne sont pas fournis.
Teil ohne Parts No. werden nicht geliefert.

NO.1

A-57 (JAPAN MADE)

Ref. No.	Address	Part No.	Description	Desti- nation	Re- marks
参照番号	位置	部品番号	部品名/規格	仕 向	備考
601	1A	A01-2948-01	METALLIC CABINET		
602	2A	A40-0488-02	PANEL ASSY		
605	1A	X94-1001-41	REMOTE CONTROL ASSY UNIT		
606	1B	A09-0115-13	BATTERY COVER		
609	2A	B01-0487-11	PANEL ESCUTCHEON		
611	2A	B12-0201-04	INDICATOR		
612	2A	B12-0202-04	INDICATOR		
613	2A	B19-1520-04	LIGHTING BOARD		
		B46-0096-33	WARRANTY CARD		
		B46-0310-03	WARRANTY CARD		
		B52-0528-00	CONNECTING DIAGRAM		
		B52-0529-00	CONNECTING DIAGRAM		
		B60-1302-00	INSTRUCTION MANUAL (ENGLISH)		
		B60-1303-00	INSTRUCTION MANUAL (FRENCH)		
		B60-1304-00	INSTRUCTION MANUAL (GERMAN)		
		B60-1305-00	INSTRUCTION MANUAL (DUTCH)		
		B60-1306-00	INSTRUCTION MANUAL (ITALIAN)		
		B60-1307-00	INSTRUCTION MANUAL (SPANISH)		
		B60-1308-00	INSTRUCTION MANUAL (ENGLISH)		
		B60-1309-00	INSTRUCTION MANUAL (SPANISH)		
		B60-1310-00	INSTRUCTION MANUAL (CHINESE)		
616	1C	E30-2277-15	AC POWER CORD		
616	1C	E30-2715-05	AC POWER CORD		
616	1C	E30-2719-05	AC POWER CORD		
616	1B	E03-0141-05	AC OUTLET		
620	2A	C11-0155-14	SGRT TAPE (40X9X2)		
		H50-0774-04	ITEM CARTON CASE		
		H50-0775-04	ITEM CARTON CASE		
		H10-5603-02	POLYSTYRENE FOAMED FIXTURE L		
		H10-5604-02	POLYSTYRENE FOAMED FIXTURE R		
		H10-5605-02	POLYSTYRENE FOAMED FIXTURE L		
		H10-5606-02	POLYSTYRENE FOAMED FIXTURE R		
		H13-0110-04	CARTON BOARD		
		H25-0232-04	PROTECTION BAG (235X350X0.03)		
		H25-0304-04	PROTECTION BAG		
		H25-0651-04	PROTECTION BAG (0232 PRINTED)		
		H25-0654-04	PROTECTION BAG (0304 PRINTED)		
625	2C	J02-0364-15	FOOT		
626	2C	J02-1040-05	FOOT		
627	2C	J12-0091-05	FRONT PIN		
628	1C	J42-0083-05	POWER CORD BUSHING		
630	2B	K27-2081-14	KNOB SPEAKER SW/GRF. A/B		
631	2A	K29-2507-04	KNOB BALANCE		
632	2A	K29-4403-04	KNOB VOLUME CONTROL		
633	2A	K29-4404-04	KNOB INPUT SELECTOR		
634	2A	K29-4405-04	KNOB BASS/TREBLE		
640	1B	L07-0794-05	POWER TRANSFORMER		
640	1B	L07-0795-05	POWER TRANSFORMER		
640	1B	L07-0796-05	POWER TRANSFORMER		
640	1B	L07-0797-05	POWER TRANSFORMER		
640	1B	L07-0798-05	POWER TRANSFORMER		

* New Parts
Parts without Parts No. are not supplied.
Les articles non mentionnés dans le Parts No. ne sont pas fournis.
Teil ohne Parts No. werden nicht geliefert.

NO.2

A-57 (SINGAPORE MADE)

Ref. No.	Address	Part No.	Description	Desti- nation	Re- marks
参照番号	位置	部品番号	部品名/規格	仕 向	備考
601	1A	A01-2948-01	METALLIC CABINET		
602	2A	A40-0488-02	PANEL ASSY		
605	1B	X94-1011-41	REMOTE CONTROL ASSY UNIT		
606	1B	A09-0126-03	BATTERY COVER		
609	2A	B01-0487-11	PANEL ESCUTCHEON		
611	2A	B12-0201-04	INDICATOR		
612	2A	B12-0202-04	INDICATOR		
613	2A	B19-1520-04	LIGHTING BOARD		
		B46-0096-33	WARRANTY CARD		
		B46-0310-03	WARRANTY CARD		
		B52-0528-00	CONNECTING DIAGRAM		
		B52-0529-00	CONNECTING DIAGRAM		
		B60-1302-00	INSTRUCTION MANUAL (ENGLISH)		
		B60-1303-00	INSTRUCTION MANUAL (FRENCH)		
		B60-1304-00	INSTRUCTION MANUAL (GERMAN)		
		B60-1305-00	INSTRUCTION MANUAL (DUTCH)		
		B60-1306-00	INSTRUCTION MANUAL (ITALIAN)		
		B60-1307-00	INSTRUCTION MANUAL (SPANISH)		
		B60-1308-00	INSTRUCTION MANUAL (ENGLISH)		
		B60-1309-00	INSTRUCTION MANUAL (SPANISH)		
		B60-1310-00	INSTRUCTION MANUAL (CHINESE)		
616	1C	E30-2277-15	AC POWER CORD		
616	1C	E30-2715-05	AC POWER CORD		
616	1C	E30-2719-05	AC POWER CORD		
616	1B	E03-0141-05	AC OUTLET		
620	2A	C11-0155-14	SGRT TAPE (40X9X2)		
		H50-0780-04	ITEM CARTON CASE		
		H50-0781-04	ITEM CARTON CASE		
		H50-0782-04	ITEM CARTON CASE		
		H50-0783-04	ITEM CARTON CASE		
		H10-5624-02	POLYSTYRENE FOAMED FIXTURE R		
		H10-5627-02	POLYSTYRENE FOAMED FIXTURE L		
		H10-5628-02	POLYSTYRENE FOAMED FIXTURE R		
		H13-0111-14	CARTON BOARD		
		H25-0232-04	PROTECTION BAG (235X350X0.03)		
		H25-0304-04	PROTECTION BAG (0232 PRINTED)		
		H25-0651-04	PROTECTION BAG (0304 PRINTED)		
		H25-0654-04	PROTECTION BAG (0304 PRINTED)		
625	2C	J02-0364-15	FOOT		
626	2C	J02-1040-05	FOOT		
627	2C	J12-0091-05	FRONT PIN		
628	1C	J42-0083-05	POWER CORD BUSHING		

PARTS LIST

A-57/77

M New Parts
 Parts without Parts No. are not supplied.
 Les articles non mentionnés dans le Parts No. ne sont pas fournis.
 Teile ohne Parts No. werden nicht geliefert.

NO.3

Ref. No.	Address	Part No.	Description	Desti- nation	Re- marks
参照番号	位置	部品番号	部品名 / 規格	仕	備考
630	2A	K23-2081-14	KN8 SPEAKER ON/OFF A/B		
631	2A	K23-2501-04	KN8 BALANCE		
632	2A	K23-4401-04	KN8 VOLUME CONTROL		
633	2A	K23-4402-04	KN8 INPUT SELECTOR		
634	2A	K29-4403-04	KN8 BASS, TREBLE		
640	1B	L07-0524-15	POWER TRANSFORMER	E	
640	1B	L07-0525-15	POWER TRANSFORMER	T	
640	1B	L07-0523-15	POWER TRANSFORMER	M	
640	1B	L07-0648-05	POWER TRANSFORMER	X	
640	1B	L07-0553-05	POWER TRANSFORMER	ETX	
640	1B	L07-0561-05	POWER TRANSFORMER	M	
640	1C	N09-2903-05	TAPITTE SCREW		
640	2B	N86-4009-45	BINDING HEAD TAPITTE SCREW		
640	1B, 2B	N87-3004-46	BRAZIER HEAD TAPITTE SCREW		
640	1B, 1C	N88-3008-45	FLAT HEAD TAPITTE SCREW		
640	1A, 1C	N89-3008-45	BINDING HEAD TAPITTE SCREW		
H	1B, 2B	N89-3008-46	BINDING HEAD TAPITTE SCREW		

M New Parts
 Parts without Parts No. are not supplied.
 Les articles non mentionnés dans le Parts No. ne sont pas fournis.
 Teile ohne Parts No. werden nicht geliefert.

NO.4

Ref. No.	Address	Part No.	Description	Desti- nation	Re- marks
参照番号	位置	部品番号	部品名 / 規格	仕	備考
-	-	H25-0651-04	PROTECTION BAG (0233 PRINTED)	T	
-	-	H25-0656-04	PROTECTION BAG (0304 PRINTED)		
625	2C	J02-0366-15	FOOT		
626	2C	J02-1040-05	FOOT		
627	2C	J12-0091-05	REAR FRONT		
628	1C	J42-0083-05	POWER CONO BUSHING		
630	2B	K27-2081-14	KN8 SPEAKER ON/OFF A/B		
631	2A	K29-2507-04	KN8 BALANCE		
632	2A	K29-4403-04	KN8 VOLUME CONTROL		
633	2A	K29-4404-04	KN8 INPUT SELECTOR		
634	2A	K29-4405-04	KN8 BASS, TREBLE		
640	1B	L07-0520-15	POWER TRANSFORMER	E	
640	1B	L07-0521-15	POWER TRANSFORMER	T	
640	1B	L07-0522-15	POWER TRANSFORMER	M	
640	1B	L07-0647-05	POWER TRANSFORMER	X	
640	1B	L07-0555-05	POWER TRANSFORMER	ETX	
H	1B, 2B	L07-0557-05	POWER TRANSFORMER	M	

USA
 Canada
 Europe
 Other Areas

△ indicates safety critical components.

USA
 Canada
 Europe
 Other Areas

△ indicates safety critical components.

PARTS LIST

A-57177

M New Parts
 Parts without Parts No. are not supplied.
 Les articles non mentionnés dans le Parts No. ne sont pas fournis.
 Teile ohne Parts No. werden nicht geliefert.

NO.9

Ref. No.	Address New Parts	Parts No.	Description	Desti- nation	Re- parts
C2		CE04KW1H010M	ELECTR0 1.0UF 50WV		1
C3		CE04LW1H010M	ELECTR0 1.0UF 50WV		2
C3		CE04KW1H220M	ELECTR0 22UF 50WV		3
C3		CE04LW1H220M	ELECTR0 22UF 50WV		4
C4		CE04KW1H010M	ELECTR0 1.0UF 50WV		5
C4		CE04LW1H010M	ELECTR0 1.0UF 50WV		6
C1		CE04KW0J471M	ELECTR0 470UF 6.3WV		7
C1		CE04LW0J471M	ELECTR0 470UF 6.3WV		8
C1		CE04KW1E100M	NP-ELEC 10UF 25WV		9
C1		CE04LW1E100M	NP-ELEC 10UF 25WV		10
C12		CE04KW1E100M	NP-ELEC 10UF 25WV		11
C12		CE04LW1E100M	NP-ELEC 10UF 25WV		12
C13		CK4SFR1H103Z	CERAMIC 0.010UF Z		13
C14		CE04KW1E470M	ELECTR0 47UF 25WV		14
C14		CE04LW1E470M	ELECTR0 47UF 25WV		15
C15		CK4SFR1H103Z	CERAMIC 0.010UF Z		16
C15		CE04KW1V100M	ELECTR0 10UF 35WV		17
C16		CE04LW1V100M	ELECTR0 10UF 35WV		18
C16		CE04KW1E470M	ELECTR0 47UF 25WV		19
C17		CE04LW1E470M	ELECTR0 47UF 25WV		20
C17		CE04KW1E470M	ELECTR0 47UF 25WV		21
C23		CE92EV1H47J3	MF 0.047UF J 35WV		22
C25		CE04KW1V100M	ELECTR0 10UF 35WV		23
C25		CE04LW1V100M	ELECTR0 10UF 35WV		24
C25		CE04KW1E470M	ELECTR0 47UF 25WV		25
C25		CE04LW1E470M	ELECTR0 47UF 25WV		26
C25		CE90-3241-05	ELECTR0 3.3UF 35WV		27
C25		CE90-3241-05	ELECTR0 3.3UF 35WV		28
C25		CE90-3241-05	ELECTR0 3.3UF 35WV		29
C25		CE90-3241-05	ELECTR0 3.3UF 35WV		30
C25		CE90-3241-05	ELECTR0 3.3UF 35WV		31
C25		CE90-3241-05	ELECTR0 3.3UF 35WV		32
C25		CE90-3241-05	ELECTR0 3.3UF 35WV		33
C25		CE90-3241-05	ELECTR0 3.3UF 35WV		34
C25		CE90-3241-05	ELECTR0 3.3UF 35WV		35
C25		CE90-3241-05	ELECTR0 3.3UF 35WV		36
C25		CE90-3241-05	ELECTR0 3.3UF 35WV		37
C25		CE90-3241-05	ELECTR0 3.3UF 35WV		38
C25		CE90-3241-05	ELECTR0 3.3UF 35WV		39
C25		CE90-3241-05	ELECTR0 3.3UF 35WV		40
C25		CE90-3241-05	ELECTR0 3.3UF 35WV		41
C25		CE90-3241-05	ELECTR0 3.3UF 35WV		42
C25		CE90-3241-05	ELECTR0 3.3UF 35WV		43
C25		CE90-3241-05	ELECTR0 3.3UF 35WV		44
C25		CE90-3241-05	ELECTR0 3.3UF 35WV		45
C25		CE90-3241-05	ELECTR0 3.3UF 35WV		46
C25		CE90-3241-05	ELECTR0 3.3UF 35WV		47
C25		CE90-3241-05	ELECTR0 3.3UF 35WV		48
C25		CE90-3241-05	ELECTR0 3.3UF 35WV		49
C25		CE90-3241-05	ELECTR0 3.3UF 35WV		50
C25		CE90-3241-05	ELECTR0 3.3UF 35WV		51
C25		CE90-3241-05	ELECTR0 3.3UF 35WV		52
C25		CE90-3241-05	ELECTR0 3.3UF 35WV		53
C25		CE90-3241-05	ELECTR0 3.3UF 35WV		54
C25		CE90-3241-05	ELECTR0 3.3UF 35WV		55
C25		CE90-3241-05	ELECTR0 3.3UF 35WV		56
C25		CE90-3241-05	ELECTR0 3.3UF 35WV		57
C25		CE90-3241-05	ELECTR0 3.3UF 35WV		58
C25		CE90-3241-05	ELECTR0 3.3UF 35WV		59
C25		CE90-3241-05	ELECTR0 3.3UF 35WV		60
C25		CE90-3241-05	ELECTR0 3.3UF 35WV		61
C25		CE90-3241-05	ELECTR0 3.3UF 35WV		62
C25		CE90-3241-05	ELECTR0 3.3UF 35WV		63
C25		CE90-3241-05	ELECTR0 3.3UF 35WV		64
C25		CE90-3241-05	ELECTR0 3.3UF 35WV		65
C25		CE90-3241-05	ELECTR0 3.3UF 35WV		66
C25		CE90-3241-05	ELECTR0 3.3UF 35WV		67
C25		CE90-3241-05	ELECTR0 3.3UF 35WV		68
C25		CE90-3241-05	ELECTR0 3.3UF 35WV		69
C25		CE90-3241-05	ELECTR0 3.3UF 35WV		70
C25		CE90-3241-05	ELECTR0 3.3UF 35WV		71
C25		CE90-3241-05	ELECTR0 3.3UF 35WV		72
C25		CE90-3241-05	ELECTR0 3.3UF 35WV		73
C25		CE90-3241-05	ELECTR0 3.3UF 35WV		74
C25		CE90-3241-05	ELECTR0 3.3UF 35WV		75
C25		CE90-3241-05	ELECTR0 3.3UF 35WV		76
C25		CE90-3241-05	ELECTR0 3.3UF 35WV		77
C25		CE90-3241-05	ELECTR0 3.3UF 35WV		78
C25		CE90-3241-05	ELECTR0 3.3UF 35WV		79
C25		CE90-3241-05	ELECTR0 3.3UF 35WV		80
C25		CE90-3241-05	ELECTR0 3.3UF 35WV		81
C25		CE90-3241-05	ELECTR0 3.3UF 35WV		82
C25		CE90-3241-05	ELECTR0 3.3UF 35WV		83
C25		CE90-3241-05	ELECTR0 3.3UF 35WV		84
C25		CE90-3241-05	ELECTR0 3.3UF 35WV		85
C25		CE90-3241-05	ELECTR0 3.3UF 35WV		86
C25		CE90-3241-05	ELECTR0 3.3UF 35WV		87
C25		CE90-3241-05	ELECTR0 3.3UF 35WV		88
C25		CE90-3241-05	ELECTR0 3.3UF 35WV		89
C25		CE90-3241-05	ELECTR0 3.3UF 35WV		90
C25		CE90-3241-05	ELECTR0 3.3UF 35WV		91
C25		CE90-3241-05	ELECTR0 3.3UF 35WV		92
C25		CE90-3241-05	ELECTR0 3.3UF 35WV		93
C25		CE90-3241-05	ELECTR0 3.3UF 35WV		94
C25		CE90-3241-05	ELECTR0 3.3UF 35WV		95
C25		CE90-3241-05	ELECTR0 3.3UF 35WV		96
C25		CE90-3241-05	ELECTR0 3.3UF 35WV		97
C25		CE90-3241-05	ELECTR0 3.3UF 35WV		98
C25		CE90-3241-05	ELECTR0 3.3UF 35WV		99
C25		CE90-3241-05	ELECTR0 3.3UF 35WV		100

M New Parts
 Parts without Parts No. are not supplied.
 Les articles non mentionnés dans le Parts No. ne sont pas fournis.
 Teile ohne Parts No. werden nicht geliefert.

NO.10

Ref. No.	Address New Parts	Parts No.	Description	Desti- nation	Re- parts
CN10-15		J13-0075-05	FUSE CLIP	ETX	1
CN14-23		J13-0075-05	FUSE CLIP	M	2
CN22-23		J13-0075-05	FUSE CLIP	ETX	3
J1-2		J21-5159-04	MOUNTING HARDWARE	ETX	4
J3-4		J21-5159-04	MOUNTING HARDWARE	M	5
X1		L78-0267-05	REGULATOR (4.194MHZ)		6
R46		R90-0493-05	MULTI-COMP 100KX9 J 1/6W		7
R46		R91-4K83A22J	FL-PR0P RS 2.2K J 1W		8
R61		R01-4N82E100J	RD 10 J 1/4W		9
R61		R01-4N82E101J	RD 100 J 1/4W		10
R61-62		R01-4N82E101J	RD 100 J 1/4W		11
VR1		R29-5072-15	VARIABLE RESISTOR(100K) VOLVME		12
VR2		R01-5086-05	POTENTIOMETER(200K) BALANCE		13
VR3-4		R10-5058-05	POTENTIOMETER(100K)BASS,TREBLE		14
X1		S76-0002-05	MAGNETIC RELAY	ETX	15
X2		S76-0002-05	MAGNETIC RELAY	M	16
S2-5		S40-1064-05	PUSH SWITCH POWER,NB,DIR,REC		17
S6		S40-1064-05	PUSH SWITCH SP GNY/RF,AYB		18
S6		S62-0001-05	SLIDE SWITCH VOLTAGE SELECTOR	M	19
S9		S31-2322-05	SLIDE SWITCH VOLTAGE SELECTOR	M	20
-7		T99-0509-05	SPEED DETECTOR INPUT SELECTOR		21
-7		HSS104	D100E	ETX	22
-7		HSS133	D100E	ETX	23
-7		HSS104	D100E	ETX	24
-7		HSS133	D100E	ETX	25
-7		HSS104	D100E	ETX	26
-7		HSS133	D100E	ETX	27
-7		HSS104	D100E	ETX	28
-7		HSS133	D100E	ETX	29
-7		HSS104	D100E	ETX	30
-7		HSS133	D100E	ETX	31
-7		HSS104	D100E	ETX	32
-7		HSS133	D100E	ETX	33
-7		HSS104	D100E	ETX	34
-7		HSS133	D100E	ETX	35
-7		HSS104	D100E	ETX	36
-7		HSS133	D100E	ETX	37
-7		HSS104	D100E	ETX	38
-7		HSS133	D100E	ETX	39
-7		HSS104	D100E	ETX	40
-7		HSS133	D100E	ETX	41
-7		HSS104	D100E	ETX	42
-7		HSS133	D100E	ETX	43
-7		HSS104	D100E	ETX	44
-7		HSS133	D100E	ETX	45
-7		HSS104	D100E	ETX	46
-7		HSS133	D100E	ETX	47
-7		HSS104	D100E	ETX	48
-7		HSS133	D100E	ETX	49
-7		HSS104	D100E	ETX	50
-7		HSS133	D100E	ETX	51
-7		HSS104	D100E	ETX	52
-7		HSS133	D100E	ETX	53
-7		HSS104	D100E	ETX	54
-7		HSS133	D100E	ETX	55
-7		HSS104	D100E	ETX	56
-7		HSS133	D100E	ETX	57
-7		HSS104	D100E	ETX	58
-7		HSS133	D100E	ETX	59
-7		HSS104	D100E	ETX	60
-7		HSS133	D100E	ETX	61
-7		HSS104	D100E	ETX	62
-7		HSS133	D100E	ETX	63
-7		HSS104	D100E	ETX	64
-7		HSS133	D100E	ETX	65
-7		HSS104	D100E	ETX	66
-7		HSS133	D100E	ETX	67
-7		HSS104	D100E	ETX	68
-7		HSS133	D100E	ETX	69
-7		HSS104	D100E	ETX	70
-7		HSS133	D100E	ETX	71
-7		HSS104	D100E	ETX	72
-7		HSS133	D100E	ETX	73
-7		HSS104	D100E	ETX	74
-7		HSS133	D100E	ETX	75
-7		HSS104	D100E	ETX	76
-7		HSS133	D100E	ETX	77
-7		HSS104	D100E	ETX	78
-7		HSS133	D100E	ETX	79
-7		HSS104	D100E	ETX	80
-7		HSS133	D100E	ETX	81
-7		HSS104	D100E	ETX	82
-7		HSS133	D100E	ETX	83
-7		HSS104	D100E	ETX	84
-7		HSS133	D100E	ETX	85
-7		HSS104	D100E	ETX	86
-7		HSS133	D100E	ETX	87
-7		HSS104	D100E		

X New Parts

Parts without Parts No. are not supplied.
Les articles non mentionnés dans le Parts No. ne sont pas fournis.
Teile ohne Parts No. werden nicht geliefert.

NO.5

Ref. No. 参照番号	Address 位置	New Part 新品	Parts No. 部品番号	Description 部品名/規格	Desti- nation 国番号	Re- marks 備考
625	2C		H50-0777-04	ITEM CARTON CASE	T	
626	2C		H50-0778-04	ITEM CARTON CASE	X	
627	1C		H50-0779-04	ITEM CARTON CASE	X	
628	1C		H10-5625-02	POLYSTYRENE FOAMED FIXTURE L	EMX	
			H10-5626-02	POLYSTYRENE FOAMED FIXTURE R	EMX	
			H10-5627-02	POLYSTYRENE FOAMED FIXTURE L	T	
			H10-5628-02	POLYSTYRENE FOAMED FIXTURE R	T	
			H13-0111-14	CARTON BOARD	X	
			H25-0232-04	PROTECTION BAG (235X350X0.03)	EMX	
			H25-0304-04	PROTECTION BAG	EMX	
			H25-0651-04	PROTECTION BAG (0232 PRINTED)	T	
			H25-0656-04	PROTECTION BAG (0304 PRINTED)	T	
629	2C		102-0346-15	FOOT REAR		
630	1C		112-0091-05	FOOT FRONT		
631	1C		142-0093-05	POWER CORO BUSHING		
632	2B		K27-2081-14	KNB SPEAKER GN/ØPC.A/B	E	
633	2A		K29-2397-04	KNB BALANCE CONTROL	T	
634	2A		K29-4403-04	KNB VOLUME SELECTOR	X	
635	2A		K29-4404-04	KNB INPUT SELECTOR	X	
636	2A		K29-4405-04	KNB BASS, TREBLE	X	
640	1B		L07-0520-15	POWER TRANSFORMER	E	
641	1B		L07-0521-15	POWER TRANSFORMER	T	
642	1B		L07-0522-15	POWER TRANSFORMER	X	
643	1B		L07-0647-05	POWER TRANSFORMER	X	
644	1B		L07-0555-05	POWER TRANSFORMER	ETX	
71			L07-0557-05	POWER TRANSFORMER	M	
72			L07-0557-05	POWER TRANSFORMER	M	
			N09-2909-05	TAPITTE SCREW		
			N86-4008-45	BINDING HEAD TAPITTE SCREW		
			N87-3006-44	RAZOR HEAD TAPITTE SCREW		
			N88-3008-45	FLAT HEAD TAPITTE SCREW		
			N89-3008-45	BINDING HEAD TAPITTE SCREW		
			N89-3008-45	BINDING HEAD TAPITTE SCREW		
			N89-3008-46	BINDING HEAD TAPITTE SCREW		
AUDIO UNIT (X09-363X-XX)						
C1.2			CC45FSL1H221J	CERAMIC	J	
C3.4			CK45FB1H222K	CERAMIC	Z	
C5.6			CK45FB1H222K	CERAMIC	K	
C7.8			CE04LM1V100M	ELECTRO	35WV	
C7.8			CE04LM1V100M	ELECTRO	35WV	
C9.10			CC45FSL1H221J	CERAMIC	J	
C9.10			CE04KM1A101M	ELECTRO	100UF	
C11.12			CE04LM1A101M	ELECTRO	10WV	
C11.12			CE04LM1A101M	ELECTRO	10WV	
C13.14			CE92PV1H222J	MF	0.012UF	
C13.14			CE92PV1H222J	MF	3300PF	
C15.16			CE04KM1A101M	ELECTRO	1.0UF	
C17.18			CE04LM1H010M	ELECTRO	50WV	
C17.18			CE04LM1H010M	ELECTRO	1.0UF	
C19.20		*	CE04KM1E470M	ELECTRO	47UF	
C19.20			CE04KM1E470M	ELECTRO	25WV	
C21.22			C91-0749-05	CERAMIC	47UF	
C21.22			C91-0749-05	CERAMIC	220PF	
C27.28			CE04KM1V100M	ELECTRO	100UF	
C27.28			CE04LM1V100M	ELECTRO	35WV	
C29.30			CC45FSL1H101J	CERAMIC	100PF	
C31.32			CE04KM1V100M	ELECTRO	100UF	
C31.32			CE04KM1V100M	ELECTRO	35WV	

LSanderson KUSA PCanada
YP/g/r East Hawaii TERland EEurope
YAAE/F/E(G/roop) XAustralia MOther Areas

J : JAPAN MADE
S : SINGAPORE MADE

5 : A-57
7 : A-77

△ indicates safety critical components.

X New Parts

Parts without Parts No. are not supplied.
Les articles non mentionnés dans le Parts No. ne sont pas fournis.
Teile ohne Parts No. werden nicht geliefert.

NO.6

Ref. No. 参照番号	Address 位置	New Part 新品	Parts No. 部品番号	Description 部品名/規格	Desti- nation 国番号	Re- marks 備考
C31.32			CE04LM1V100M	ELECTRO	100UF	
C32.34			C91-0749-05	CERAMIC	220PF	
C35.36			CC45FSL1H221J	CERAMIC	220PF	
C37.38			CE04KM1V100M	ELECTRO	10UF	
C37.38			CE04LM1V100M	ELECTRO	35WV	
C39.40			CC45FSL1H101J	CERAMIC	100PF	
C41.42			CE04KM1V100M	ELECTRO	10UF	
C41.42			CE04LM1V100M	ELECTRO	35WV	
C43.44			CC45FSL1H221J	CERAMIC	220PF	
C43.44			CE04KM1H0R1M	ELECTRO	1.0UF	
C49.50			CE04KM1V100M	ELECTRO	100UF	
C49.50			CE04LM1H0R1M	ELECTRO	0.1UF	
C49.50			CE04LM1V100M	ELECTRO	10UF	
C49.50			CE92PV1H473J	MF	0.047UF	
C51.52			CK45FB1HS61K	CERAMIC	560PF	
C53.54			CE04KM1V100M	ELECTRO	10UF	
C53.54			CE04LM1V100M	ELECTRO	35WV	
C55.56			CE92PV1H124J	MF	0.12UF	
C57.58			CE04KM1V100M	ELECTRO	1.0UF	
C57.58			CE04LM1V487M	ELECTRO	4.7UF	
C57.58			CE04LM1H010M	ELECTRO	1.0UF	
C57.58			CE04LM1V487M	ELECTRO	4.7UF	
C59.60			CE04LM1H010M	ELECTRO	1.0UF	
C59.60			CE04LM1V487M	ELECTRO	4.7UF	
C61.62			CE04LM1E70M	ELECTRO	47UF	
C63.64		*	CK45FB1H103Z	CERAMIC	0.010UF	
C65.66			CK45FB1H222K	CERAMIC	2200PF	
C67.70			CE92PV1H104J	MF	0.10UF	
C71.72			C90-1942-05	ELECTRO	6800UF	
C71.72			C90-1942-05	ELECTRO	6800UF	
C71.72			C90-1943-15	ELECTRO	5500UF	
C71.72			CE92PV1H682J	MF	6800PF	
C73.76			CC45FSL1H221J	CERAMIC	220PF	
C77.78			CE04KM1A101M	ELECTRO	100UF	
C79			CE04LM1A101M	ELECTRO	10WV	
C79			CE04LM1A101M	ELECTRO	10WV	
C81			CE04LM1H010M	ELECTRO	1.0UF	
C81			CE04LM1H010M	ELECTRO	50WV	
C82			CE04LM1V100M	ELECTRO	1.0UF	
C82			CE04LM1V100M	ELECTRO	35WV	
C102			CK45FB1H102K	CERAMIC	1000PF	
C103			CK45FB1H222K	CERAMIC	2200PF	
C104			CK45FB1H102K	CERAMIC	1000PF	
C105			CK45FB1H222K	CERAMIC	2200PF	
C106.107			CK45FB1H102K	CERAMIC	1000PF	
C110			CE04KM1E102M	ELECTRO	1000UF	
C110			CE04LM1E102M	ELECTRO	25WV	
C111.112			CE92PV1H124J	MF	0.12UF	
C113			CE04KM1A101M	ELECTRO	100UF	
C113			CE04LM1A101M	ELECTRO	10WV	
C114			CE92PV1H124J	MF	0.12UF	
C115			CE04KM1V102M	ELECTRO	1000UF	
C115			CE04LM1V102M	ELECTRO	35WV	
C116			CE04KM1C101M	ELECTRO	1000UF	
C116			CE04LM1C101M	ELECTRO	16WV	

LSanderson KUSA PCanada
YP/g/r East Hawaii TERland EEurope
YAAE/F/E(G/roop) XAustralia MOther Areas

J : JAPAN MADE
S : SINGAPORE MADE

5 : A-57
7 : A-77

△ indicates safety critical components.

PARTS LIST

A-57/77

M New Parts
Parts without Parts No. are not supplied.
Les articles non mentionnés dans le Parts No. ne sont pas fournis.
Telles ohne Parts No. werden nicht geliefert.

NO.7

Ref. No.	Address	Part's No.	Description	Desti- nation	Re- marks
参照番号	位置	部品番号	部品名/規格	仕	備考
C116		CE04LW1C101M	ELECTRO	S	
C117, 118		CE04LW1C101M	ELECTRO	S	
C119		CE04LW1C101M	ELECTRO	S	
C120		CE04LW1C101M	ELECTRO	S	
C120		CE04LW1C101M	ELECTRO	S	
C121		CE04LW1C101M	ELECTRO	S	
C122, 123		CE04LW1C101M	ELECTRO	S	
C124		CE04LW1C101M	ELECTRO	S	
C125		CE04LW1J100M	ELECTRO	S	
C126		CE04LW1J100M	ELECTRO	S	
C129		CE04LW1V100M	ELECTRO	S	
C130		CE04LW1H222Z	CERAMIC	S	
C131		CE04LW1C101M	ELECTRO	S	
C132, 133		CE04LW1C101M	ELECTRO	S	
C134		CE04LW1C101M	ELECTRO	S	
C134-137		CK45FF1H103Z	CERAMIC	S	
J1		E13-0249-05	PHONE JACK	S	
J2		E13-0633-05	PHONE JACK	S	
J3		E13-0445-05	PHONE JACK	S	
J4		E13-0433-05	PHONE JACK	S	
J5		E20-0823-05	LOCK TERMINAL BOARD SPEAKERS	S	
J6		E13-0313-05	PHONE JACK	S	
J7		E11-0208-05	PHONE JACK	S	
445	1C	F20-1284-05	INSULATING BOARD	S	
445	1C	F20-1284-05	INSULATING BOARD	S	
445	1C	F20-1297-05	INSULATING SHEET	S	
645	1C	F20-1297-05	INSULATING SHEET	S	
F1, 2		F08-1022-05	FUSE (SEMKO) (250V T1AL)	S	
F3		F03-2528-05	FUSE (SEMKO) (250V T2.5A)	S	
F3		F03-4028-05	FUSE (SEMKO) (250V T4A)	S	
F5		F03-1623-05	FUSE (SEMKO) (250V T1.5A)	S	
-		J11-0098-05	WIRE CLAMPER	S	
-		J13-0078-05	FUSE CLIP	S	
L1		L39-0093-05	PHASE COMPENSATION COIL	S	
C91, 2		R90-0191-05	KUL.TI-COMP	S	
C91, 2		R90-0828-05	KUL.TI-COMP	S	
R91, 18		R314K8B3A101J	FL-PROOF RS	S	
R91, 90		R314K8B3A101J	FL-PROOF RS	S	
R91-100		R014NB284R7J	RD	S	
R105, 106		R314K8B30100J	FL-PROOF RS	S	
R107, 108		R014NB28100J	RD	S	
R115, 116		R314K8B30311J	FL-PROOF RS	S	
R163		R314K8B30470J	FL-PROOF RS	S	
R163		R314K8B30820J	FL-PROOF RS	S	
R171		R314K8B30181J	FL-PROOF RS	S	
K1, 2		S76-0005-05	MAGNETIC RELAY	S	

LS:Osaka
WPA/East (Hawaii)
YAA/E(S/T/roop)

KUSA
TEland
Kauai

Pcanada
Europe
MOer Area

J : JAPAN MADE
S : SINGAPORE MADE
5 : A-57
7 : A-77

△ indicates safety critical components.

M New Parts
Parts without Parts No. are not supplied.
Les articles non mentionnés dans le Parts No. ne sont pas fournis.
Telles ohne Parts No. werden nicht geliefert.

NO.8

Ref. No.	Address	Part's No.	Description	Desti- nation	Re- marks
参照番号	位置	部品番号	部品名/規格	仕	備考
D1 -6		HS5104	D100E	S	
D1 -6		HS5133	D100E	S	
D1 -34		HS5104	D100E	S	
D1 -34		HS5133	D100E	S	
D1, 32		HS5104	D100E	S	
D35 -42		1S5133	D100E	S	
D35 -42		SS4888	D100E	S	
D44, 45		1S5139-100	D100E	S	
D44, 45		HS5104	D100E	S	
D44, 45		1S5133	D100E	S	
D46		DS59A20S03	D100E	S	
D46		R8V-402LFA	D100E	S	
D47		HS5104	D100E	S	
D47		1S5133	D100E	S	
D48		HS24, 7N(92)	ZENER D100E	S	
D48		DS59A20S03	ZENER D100E	S	
D48		R8V-402LFA	ZENER D100E	S	
D49 -54		HS5104	D100E	S	
D49 -54		1S5133	D100E	S	
D69		BS15218-0X	IC(9P AMP X2)	S	
D70		XRA15218-0X	IC(9P AMP X2)	S	
D70		XRA15218-0X	IC(9P AMP X2)	S	
D71		HS24, 7N(92)	ZENER D100E	S	
D72		NJM2058D	IC(9P AMP X4)	S	
D72		UPC4574C	IC(9P AMP X4)	S	
D73		BA15218-DX	IC(9P AMP X2)	S	
D73		XRA15218-0X	IC(9P AMP X2)	S	
D74		NU7313L	IC(ANALOG SWITCH)	S	
D74		TC9164N	IC(16CH BILATERAL SELECTOR SW)	S	
D75		BA15218-DX	IC(9P AMP X2)	S	
D76		KAI5218-0X	IC(9P AMP X2)	S	
D76		NU7711L	IC(ANALOG SWITCH)	S	
D76		TC9162N	IC(ANALOG SWITCH ARRAY)	S	
D77		AN7905F	IC(VOLTAGE REGULATOR/ +5V)	S	
D77		T79805S	IC(VOLTAGE REGULATOR/ +5V)	S	
D77		UPC7805AHP	IC(VOLTAGE REGULATOR/ +5V)	S	
D77		T79815S	IC(VOLTAGE REGULATOR/ +5V)	S	
D78		UPC7815AMP	IC(VOLTAGE REGULATOR/ +15V)	S	
D79		T79015S	IC(VOLTAGE REGULATOR/ +15V)	S	
D79		UPC7915HP	IC(VOLTAGE REGULATOR/ -15V)	S	
D79		2SC1845(F, G)	TRANSISTOR	S	
D79		2SC2878(A, B)	TRANSISTOR	S	
D80		2SC4137(V, W)	TRANSISTOR	S	
D81, 12		2SC1845(F, E)	TRANSISTOR	S	
D81, 12		2SD0254	TRANSISTOR	S	
D81, 12		2SD0240	TRANSISTOR	S	
D81, 12		2SB1492	TRANSISTOR	S	
D81, 12		2SB1531	TRANSISTOR	S	
D82		2SC2003(L, K)	TRANSISTOR	S	
D82		2SC2878(A, B)	TRANSISTOR	S	
D82		2SC2003(L, K)	TRANSISTOR	S	
D82		2SA1178(F, E)	TRANSISTOR	S	
D82		2SA9335(Q, R)	TRANSISTOR	S	

LS:Osaka
WPA/East (Hawaii)
YAA/E(S/T/roop)

KUSA
TEland
Kauai

Pcanada
Europe
MOer Area

J : JAPAN MADE
S : SINGAPORE MADE
5 : A-57
7 : A-77

△ indicates safety critical components.

PARTS LIST

PARTS LIST

NO.12

* New Parts
Parts without Parts No. are not supplied.
Les articles non mentionnés dans le Parts No. ne sont pas fournis.
Teile ohne Parts No. werden nicht geliefert.

Table with columns: Ref. No., Address, Parts No., Description, Destination. Includes parts like AC GUTLET, FUSE, WIRE CLAMPER, RESONATOR, etc.

J: JAPAN MADE
S: SINGAPORE MADE
5: A-57
7: A-77
Indicates safety critical components.

NO.11

* New Parts
Parts without Parts No. are not supplied.
Les articles non mentionnés dans le Parts No. ne sont pas fournis.
Teile ohne Parts No. werden nicht geliefert.

Table with columns: Ref. No., Address, Parts No., Description, Destination. Includes parts like TRANSISTOR, ELECTRIC CIRCUIT MODULE, CERAMIC, etc.

J: JAPAN MADE
S: SINGAPORE MADE
5: A-57
7: A-77
Indicates safety critical components.

PARTS LIST

NO.14

* New Parts
Parts without Parts No. are not supplied.
Les articles non mentionnés dans le Parts No. ne sont pas fournis.
Teile ohne Parts No. werden nicht geliefert.

Ref. No. 参照番号	Address 位置	Parts No. 部品番号	Description 部品名 / 規格	Desti- nation 仕	Re- marks 備考
D1 .2		1SS133	DIODE		
D3		HSS1044	DIODE		
D3		1SS131	DIODE		
Q1 -4		2SA992(F,E)	TRANSISTOR		
Q5 -8		2SC1845(F,E)	TRANSISTOR		
Q9 .10		2SA992(F,E)	TRANSISTOR		
Q11		2SC1740S(Q,R)	TRANSISTOR		
Q11		2SC2459(Y,GR)	TRANSISTOR		
Q11		2SC2785(F,E)	TRANSISTOR		
Q11		2SC3311A(Q,R)	TRANSISTOR		
Q12		DTC124ES	DIGITAL TRANSISTOR		S
Q12		UN4212	TRANSISTOR		J S

L:Scandinavia
Y/P(Far East, Hawaii)
Y:AAFESE(Europe)

K:USA
T:England
X:Australia

F:Canada
E:Europe
M:Other Areas

J: JAPAN MADE
S: SINGAPORE MADE
5: A-57
7: A-77

△ indicates safety critical components.

NO.13

* New Parts
Parts without Parts No. are not supplied.
Les articles non mentionnés dans le Parts No. ne sont pas fournis.
Teile ohne Parts No. werden nicht geliefert.

Ref. No. 参照番号	Address 位置	Parts No. 部品番号	Description 部品名 / 規格	Desti- nation 仕	Re- marks 備考
D15		R05.1E5(B2)	ZENER DIODE		
D16		R25.7N(B2)	ZENER DIODE		
D16		R04.7E5(B2)	ZENER DIODE		
D17		R25.16N(B2)	ZENER DIODE		
D17		R01.6E5(B2)	ZENER DIODE		
D18		R25.13N(B2)	ZENER DIODE		
D18		R01.3E5(B2)	ZENER DIODE		
D23		HSS1044	DIODE		
D23		1SS131	DIODE		
D23		1SS133	DIODE		
D24		HSS1044	DIODE		
D24		1SS131	DIODE		
D24		HSS104	DIODE		
D25		1SS133	DIODE		
D25		CM1154C	INDICATOR TUBE		
BD1		UP0752460W-044	IC(4BIT MICROPROCESSOR)		
IC1		PST529D	IC(SYSTEM RESET)		
IC2		NJM4545L-0	IC(IMP. AMP. X2)		
IC3 .4		T8A09S	IC(MOTOR CONTROL)		
IC5		2SA957(L,K)	TRANSISTOR		
Q1		2SA1048(Y,GR)	TRANSISTOR		J
Q3		2SA1175(F,E)	TRANSISTOR		S
Q3		2SA1309A(Q,R)	TRANSISTOR		J
Q3		2SA935(Q,R)	TRANSISTOR		S
Q5 .6		2SC1845(F,E)	TRANSISTOR		
Q7		2SA1048(Y,GR)	TRANSISTOR		J
Q7		2SA1175(F,E)	TRANSISTOR		S
Q7		2SA1309A(Q,R)	TRANSISTOR		J
Q9		2SA935(Q,R)	TRANSISTOR		S
Q9		2SC2878(A,B)	TRANSISTOR		S
Q9		W02-1046-05	ELECTRIC CIRCUIT MODULE		
A1		MAIN AMPLIFIER UNIT (X85-122X-XX)			
C1		CE04K1H010M	ELECTRO 1.0UF 50WV		J S
C1		CE04L1H010M	ELECTRO 1.0UF 50WV		
C3 .4		CK45F1H471K	CERAMIC 470PF K		
C5 .6		C90-1844-05	ELECTRO 470UF 6.3WV		
C7 .8		CC45FSL1H121J	CERAMIC 120PF J		
C9		CC45FSL1H020C	CERAMIC 2.0PF C		
C11 .12		CC45FSL1H221J	CERAMIC 220PF J		
C13 .14		CC45FSL1H390J	CERAMIC 39PF J		
C15 .16		CC45FSL1H221J	CERAMIC 220PF J		
C17 .18		CE04K1H470M	ELECTRO 47UF 50WV		J
C17 .18		CE04L1H470M	ELECTRO 47UF 50WV		S
C19		CE04M1V477M	NP-ELEC 4.7UF 35WV		
C20		CE04L1V477M	ELECTRO 4.7UF 35WV		J S
R5 .6		RN14BK2C22151F	RN 2.15K F 1/6W		
R5 .6		RN14BK2C2371F	RN 2.37K F 1/6W		ET
R5 .6		RN14BK2C2611F	RN 2.61K F 1/6W		ET
R5 .6		RN14BK2C2871F	RN 2.87K F 1/6W		ET
R15 .16		R0146B28271J	FL-PR00E R0 270 J 1/4W		FX
R21 -24		R0146B28211J	FL-PR00E R0 220 J 1/4W		
R25 .26		R0146B28470J	FL-PR00E R0 47 J 1/4W		
D1 .2		HSS104	DIODE		

L:Scandinavia
Y/P(Far East, Hawaii)
Y:AAFESE(Europe)

K:USA
T:England
X:Australia

F:Canada
E:Europe
M:Other Areas

J: JAPAN MADE
S: SINGAPORE MADE
5: A-57
7: A-77

△ indicates safety critical components.